

10
9
8
7
6
5
4
3
2
1

RoHS Compliant  THIS DRAWING CONTAINS INFORMATION THAT IS PROPRIETARY TO ZDT TECHNOLOGY, AND SHOULD NOT BE USED WITHOUT WRITTEN PERMISSION

REV	ECN No.	DATE	REMARK
A	NEW	2018.12.25	NEW RELEASE

TYPE C协会TID NO. 2045

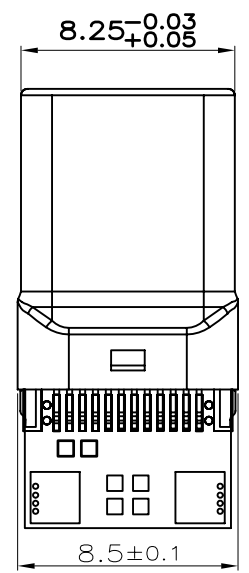
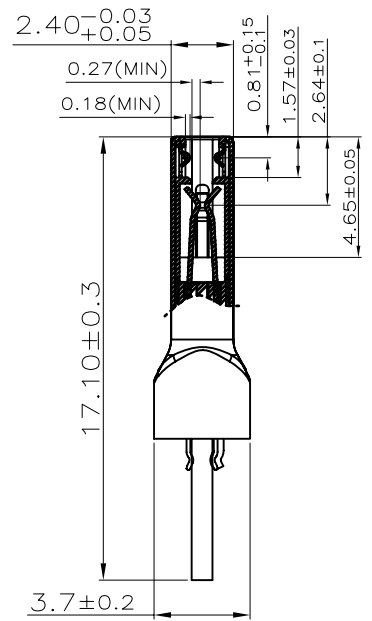
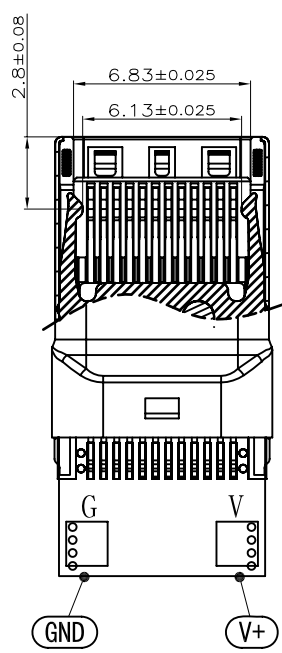
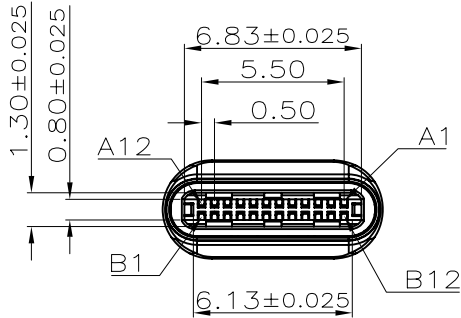

备注:

1.电性参数

电流: 3.0A Max,
接触电阻: 最初40mΩ Max,
寿命测试后变化±10
绝缘阻抗: 100MΩ Min
耐压: 100V AC

2.机械参数

插入力: 5-20N MAX.
拔出力: 8-20N MIN.
耐久性: 10000 Cycles 500
cycles per hour

3.沾锡性: 温度250±5° , 时间5±0.5s

4. PCB双层板

5. PART NUMBER CODE:

C M 091 - 24 L X XX T - XX - 97
(1) (2) (3)

(1) HOUSING COLOR:
B:BLACK
W:WHITE

(2) CONTACTS PLATED:
01:半金锡1u"

(3) PCB板规格:
02:带板2.0,电阻56K
31: 2.0 A TO C 10k电阻

7	PCB	1PCS	FR-4 PCB线路板 蓝油 T=0.8mm +电阻
6	SPRING	1PCS	SUS 301 HV310-370;T=0.40. 镀可焊镍
5	TERMINAL	24PCS	C7025 HV190-210;T=0.15,Au:足1U,锡100u",盐雾48H
4	EMI PLATE	2PCS	SUS 304 HV310-370;T=0.10
3	FRONT SHELL	1PCS	SUS 304/316 HV310-370;T=0.15,Ni 80u"最小盐雾48H
2	EMI-Molding	2PCS	LCP+30%G.F UL94-V0
1	TERMINAL-Molding	2PCS	LCP+30%G.F UL94-V0
No.	NAME	Q'TY	MATERIAL

PART NO.:
SEE THE PART NUMBER CODE

 深圳市中科兴达科技有限公司
SHENZHEN ZDT TECHNOLOGY CO.,LTD

DRAWN BY SAM DATE 2018.12.25

QUALITY SYMBOL	0	GENERAL TOLERANCES (UNLESS SPECIFIED)
	x.xxxx	± ---
	x.xxx	± 0.10
	x.xx	± 0.25
	x.x	± 0.30
ANGULAR	± ---°	

TITLE
USB Type C/M 2.0 2焊盘

CHECKED BY JAY DATE 2018.12.25

DWG.NO. CM091-24-97 SHEET NO. 1 OF 2

APPROVED BY JACKY DATE 2018.12.25

DIMENSION STYLE MM ONLY DESIGN UNITS METRIC SCALE 1:1

THIRD ANGLE PROJECTION

frame size: A4

10 9 8 7 6 5 4 3 2 1

RoHS Compliant  THIS DRAWING CONTAINS INFORMATION THAT IS PROPRIETARY TO ZDT TECHNOLOGY, AND SHOULD NOT BE USED WITHOUT WRITTEN PERMISSION

REV	ECN No.	DATE	REMARK
A	NEW	2018.12.25	NEW RELEASE

TYPE C协会TID NO. 2045

线路图

2.0 56K电阻

线路原理图	
PLUG端	PCB焊盘
A1, A12, B1, B12, Shell	GND
A4, A9, B4, B9	VBUS
A5	
A6	
A7	

电阻 56K 

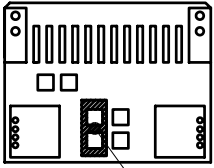

电阻: 56K (VBUS & A5)

2.0 10K电阻

线路原理图	
PLUG端	PCB焊盘
A1, A12, B1, B12, Shell	GND
A4, A9, B4, B9	VBUS
A5	
A6	
A7	

电阻 10K 

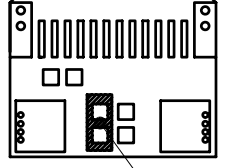

电阻: 10K (VBUS & A5)

PART NO.: SEE THE PART NUMBER CODE		 深圳市中兴兴达科技有限公司 SHENZHEN ZDT TECHNOLOGY CO., LTD		DRAWN BY SAM	DATE 2018.12.25	
QUALITY SYMBOL 0 0 0 0 0	GENERAL TOLERANCES (UNLESS SPECIFIED)		TITLE USB Type C/M 2.0 2焊盘			
	x.xxxx	± ---	DWG.NO. CM091-24-97	SHEET NO. 2 OF 2	CHECKED BY JAY	DATE 2018.12.25
	x.xxx	± 0.10			APPROVED BY JACKY	DATE 2018.12.25
	x.xx	± 0.25				
	x.x	± 0.30				
ANGULAR	± ---°	DIMENSION STYLE MM ONLY			DESIGN UNITS METRIC	SCALE 1:1